



# ALU Ranger VGroove

High Throughput CNC Panel Router  
with Vertical Table for Architectural Panels

4221

6321

10121



High Throughput CNC Panel Router  
with Vertical Table for Architectural Panels

**CNC panel router made for: ACM/ACP, ACM Mineral core, solid aluminium, panels with alu honeycomb and corrugated core, Fibrecement, HPL.**



# ALU RANGER

## COMPATIBLE PANELS

### ACM / ACP PE CORE MINERAL CORE

ALUCOBOND®  
LARSON®  
ALPOLIC®  
ARCONIC®  
ALUBOND®  
ALBOND®  
SIBALUX®  
VITRABOND®  
STACBOND®  
ALUPANEL®  
NEOBOND®  
.....

### SOLID ALU

VITRADUAL®  
LUXE COAT®  
ALUCOLUX®  
FUTURAL®  
.....

### ALU HONEYCOMB

ALUCORE®  
LARCORE®  
PLASCORE®  
STARCELL®  
CELCOMPONENTS®  
HONYLITE®  
.....

### ALUMINIUM CORRUGATED CORE

METAWELL®  
DOLUFLEX®  
.....

### FIBER CEMENT

CEMBRIT®  
EQUITONE®  
COPANEL®  
SWISS PEARL®  
.....

### HPL

TRESPA®  
MAX EXTERIOR®  
POLYREY®  
RESOPAL®  
FUNDERMAX®  
.....

# NO WASTED SPACE

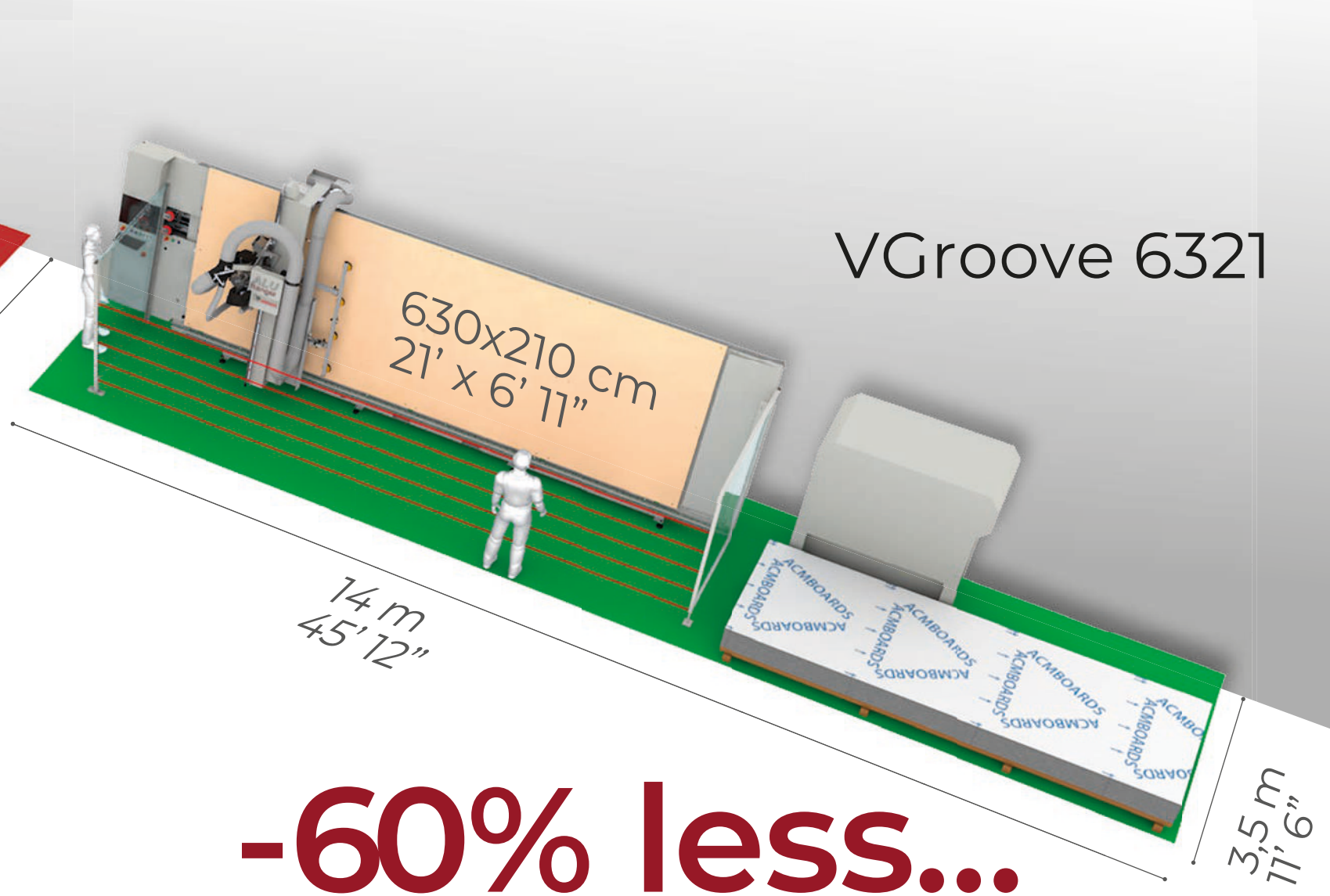
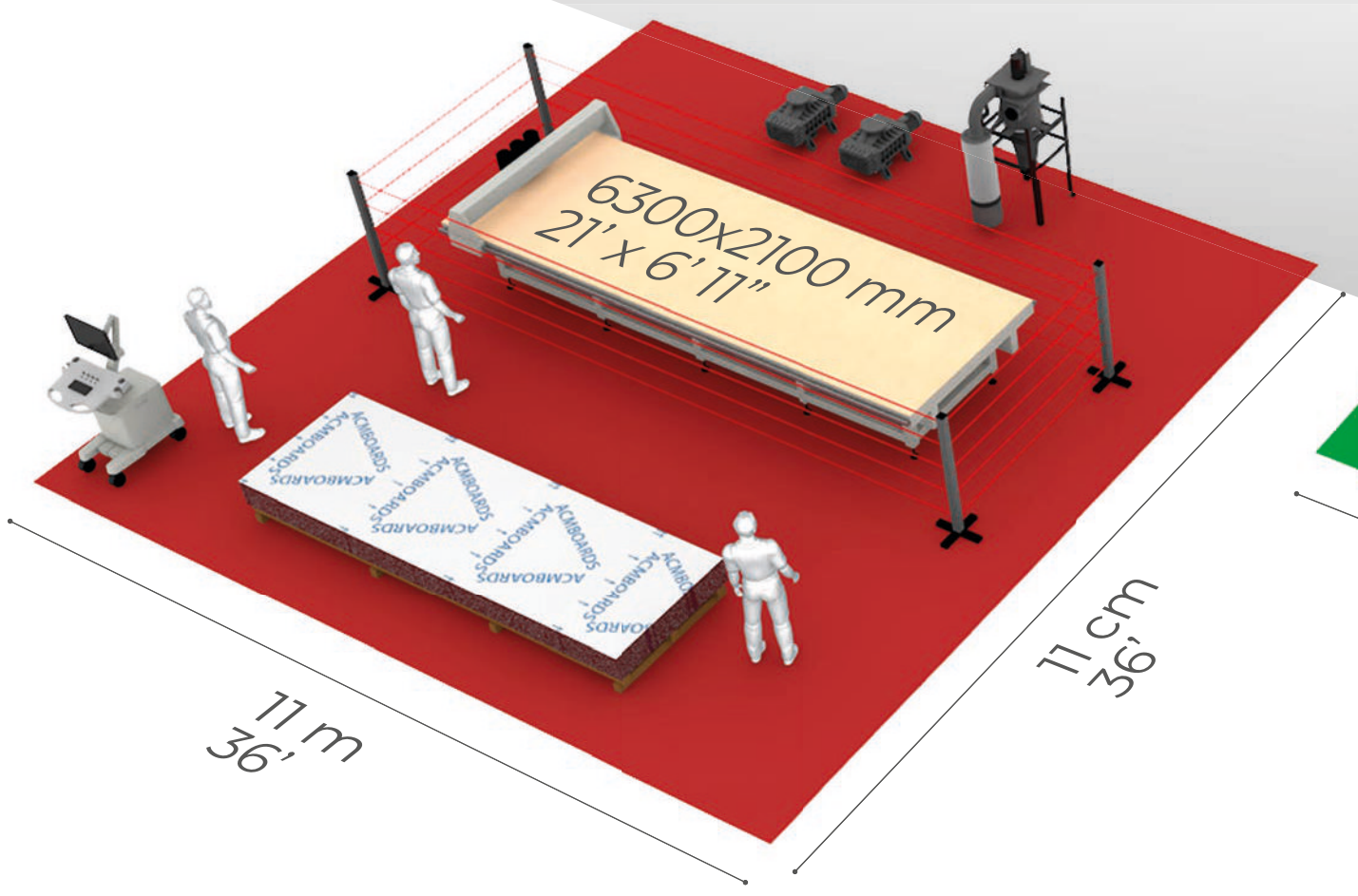

## -60% less...

- ...floor space required than a horizontal router system
- Designed to occupy less space
- Ergonomic access to the Vertical Table
- Safer work environment for the operator
- Eliminate table prep, debris not held falls to the floor

CNC PANEL ROUTER  
WITH HORIZONTAL TABLE

LAYOUT **121** sq mt - (1305 sq ft)

WORKING TABLE **14** sq mt - (151 sq ft)

CNC PANEL ROUTER  
WITH VERTICAL TABLE

LAYOUT **49** sq mt - (527 sq ft)

WORKING TABLE **14** sq mt - (151 sq ft)



# LOAD AND OFFLOAD

## ALU Ranger

**CNC Panel Router with Vertical Table**  
for architectural facades panels fabrication.

### Integrated automation

- Automatic loading and positioning without operators
- Increased productivity
- Zero risk of panels falling with patented holding device
- Ergonomically designed for easy panel off-loading

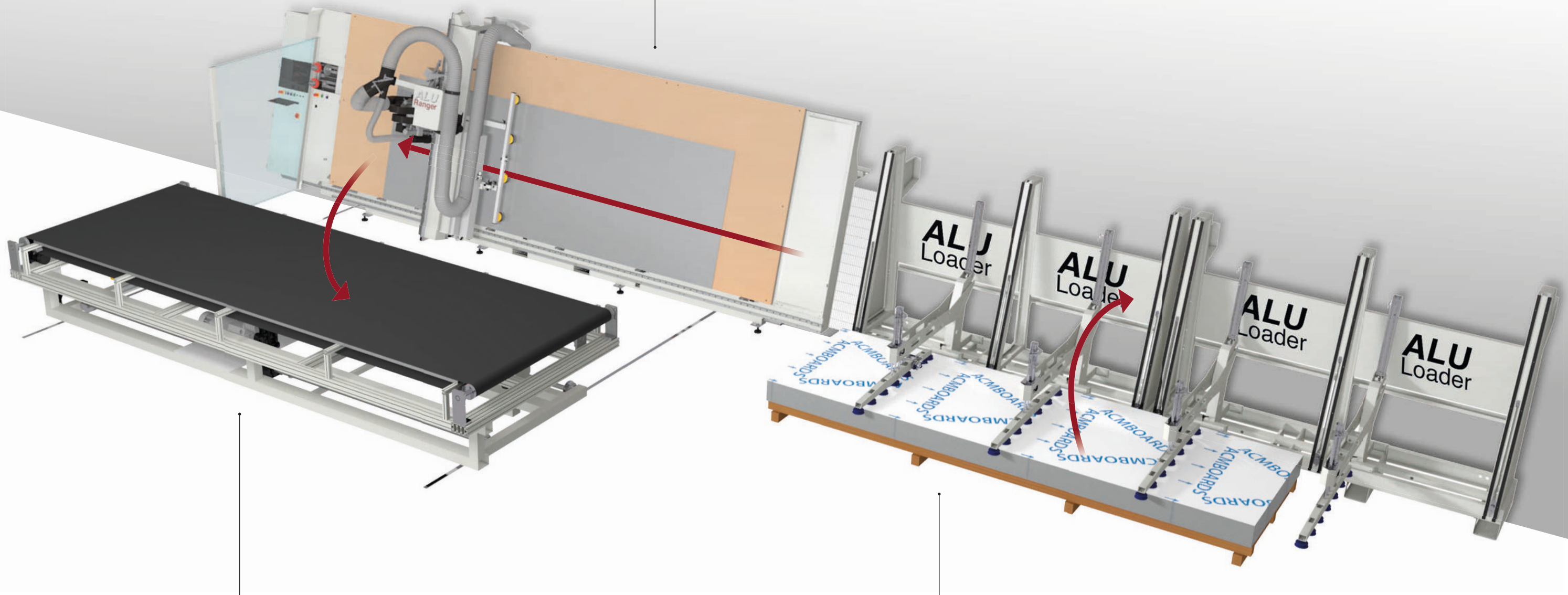

## OFF Loader

**Automatic Off Loader**  
for processed panels by a tiltable vacuum holding table. Patented.

## ALU Loader

**Loading - Positioning**  
device for architectural panels with holding arms with suction cups connected to the vacuum system of ALU Ranger. Patented.

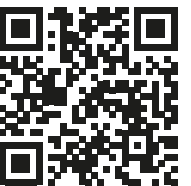

# STRONG HOLD

- Vacuum zones designed for standard ACM panels
- Easy Release for processed panels (patent pending)
- No risk of panels falling during off-loading
- Vacuum pumps integrated inside the machine frame: less space required and reduced noise
- Possibility of resuming work on panels that have not been unloaded without losing the references

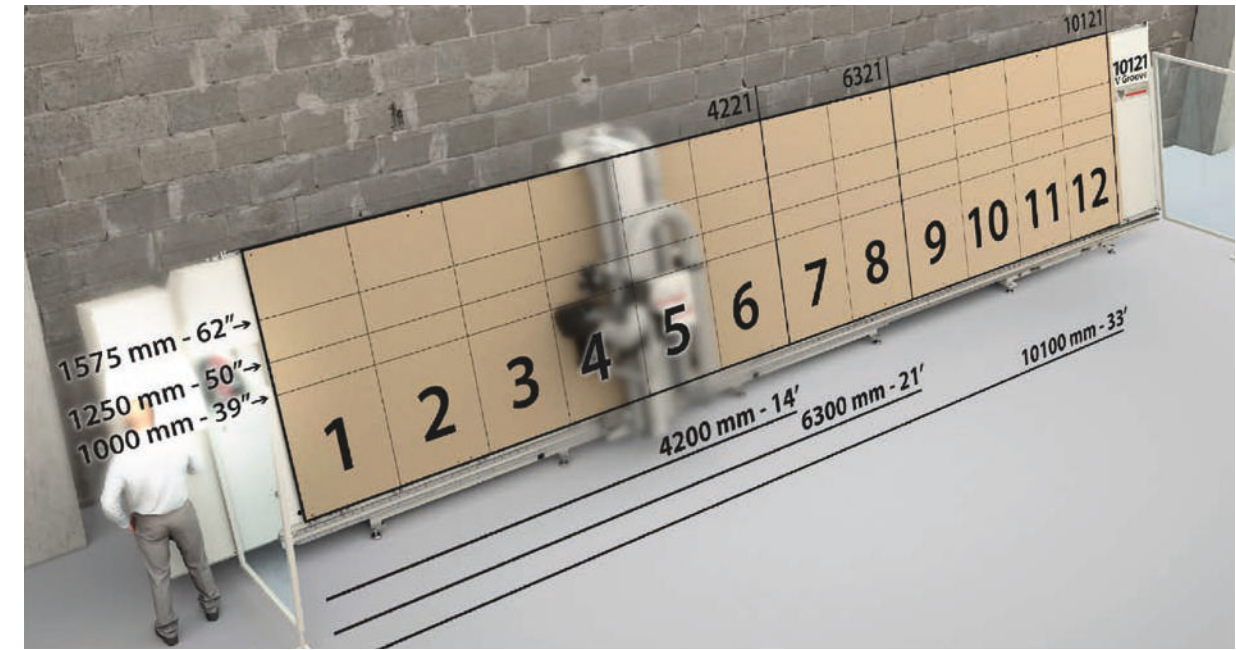

Piano di lavoro a depressione con pannello martire traspirante in MDF

- **Rapid selection of 24, 32 and 48** (respectively 4221, 6321, 10121) combinations of vacuum zones according to the ACM panel size (1.000–1.250–1.575 mm) (39"–50"–62")
- **Rapid selection of 24, 32, 48** (respectively 4221, 6321, 10121) combinations of vacuum zones according to the ACM panel size (1.000–1.250–1.575 mm) (39"–50"–62")



Dry vacuum pumps (Made in Germany)

- **4221 VGroove** 1x250m<sup>3</sup>/h pump Std
- **6321 VGroove** 2x250m<sup>3</sup>/h pumps Std
- **10121 VGroove** 4x250m<sup>3</sup>/h pumps Std



# DOUBLE-HEADED

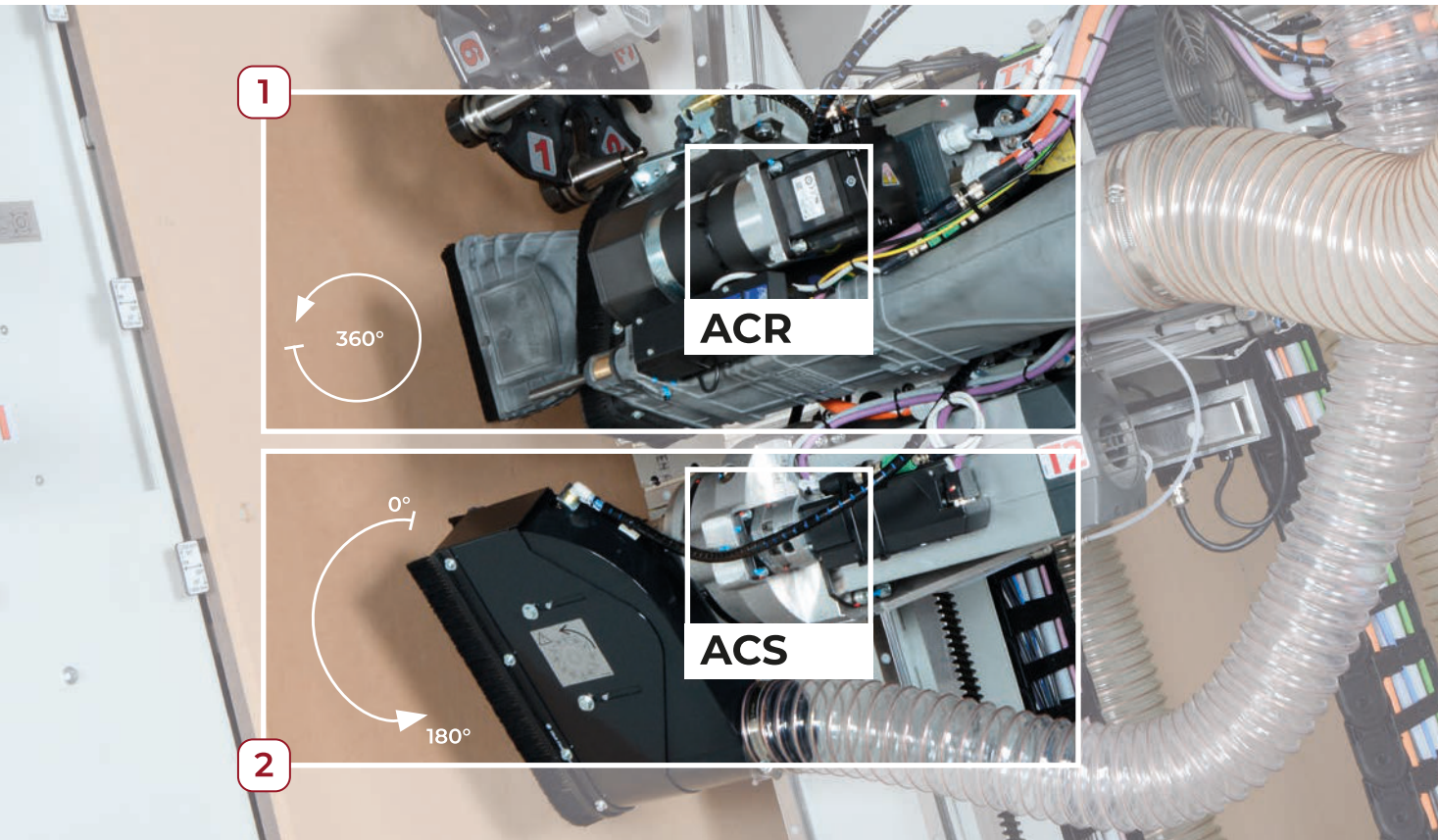

1

## R8A - TC6L

ELECTROSPINDLE FOR FLUTE TOOLS AND AGGREGATES

- High-efficiency electrospindle
- High-resistance ceramic bearings
- Power 8 kW - up to 24000 RPM - Electroventilated
- Rotary tool changer ( flute tools) 6 positions ISO 30 Cones - Collet ER32
- Numerical controlled integrated swarf collection hood (patented)

### ACR OPTION

- Fourth positioning Axis 0-360° to cut in any direction with aggregates

2

## VGroove V175 / S200 / S250

INDEPENDENT AND SEPARATED ANGULAR ELECTROSPINDLE FOR GROOVING / CUTTING AT HIGH SPEED

- Power 5 kW - up to 8000 RPM
- Carbide Vgrooving cutterhead ø175mm (Opt.)
- Integrated dust collection hood
- Sizing cuts on HPL with ø 200 mm - 8" or ø 250 mm - 10" saw blade (Opt.)
- Fourth positioning Axis from 0 to 180° for Vgrooving disc or sawblade

## The unit

# VGroove V175 / S200 / S250

- Direct power to the tool (no aggregate)
- High speed processing
- Ready to go (no tool change)
- Longer tool lifespan compared to flute tools
- Dedicated dust collection hood

V GROOVE WHISPERCUT®  
MADE BY LEITZ

## VGroove V175

ø 175 mm

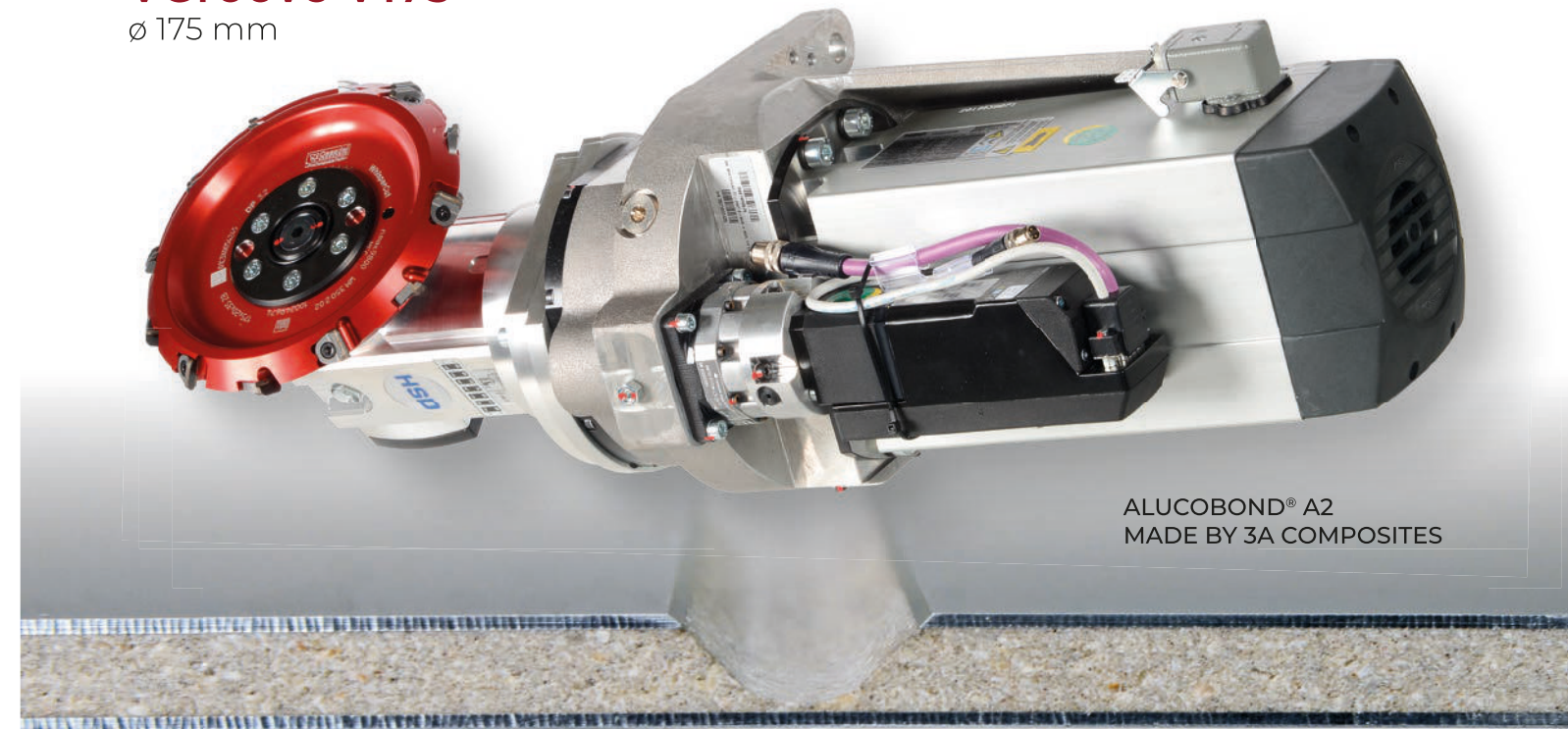

ALUCOBOND® A2  
MADE BY 3A COMPOSITES

## Saw blade / S200 / S250

ø 200 mm - ø 250 mm

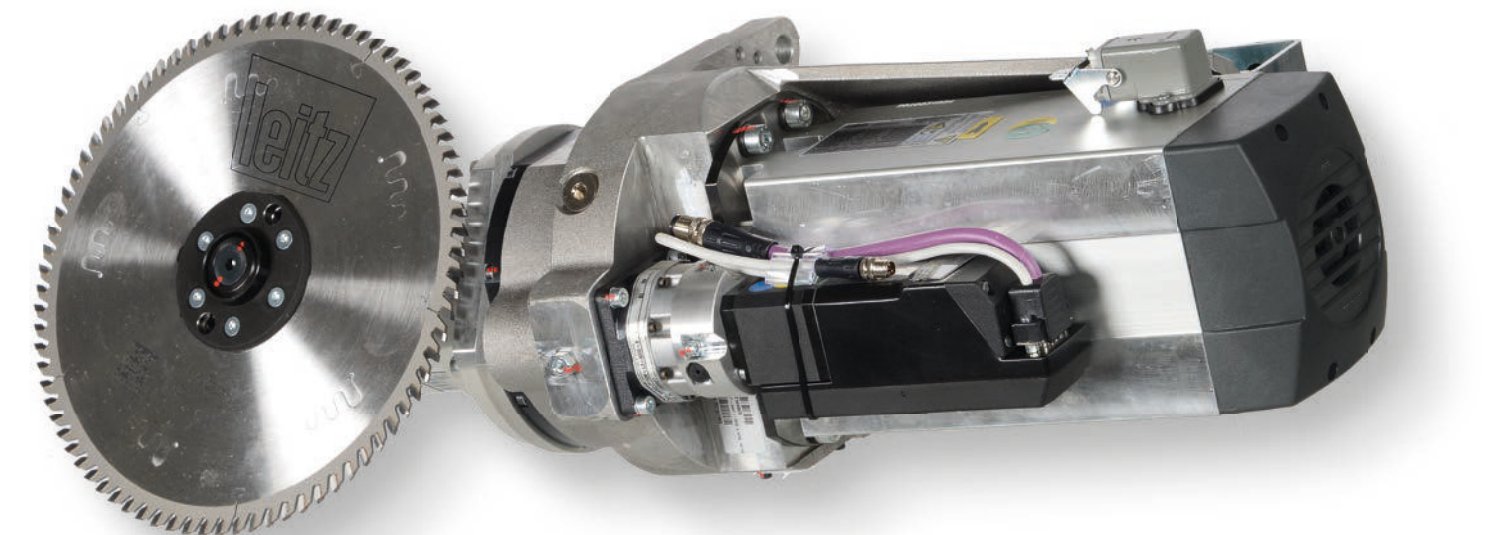

# VERSATILE AND FAST

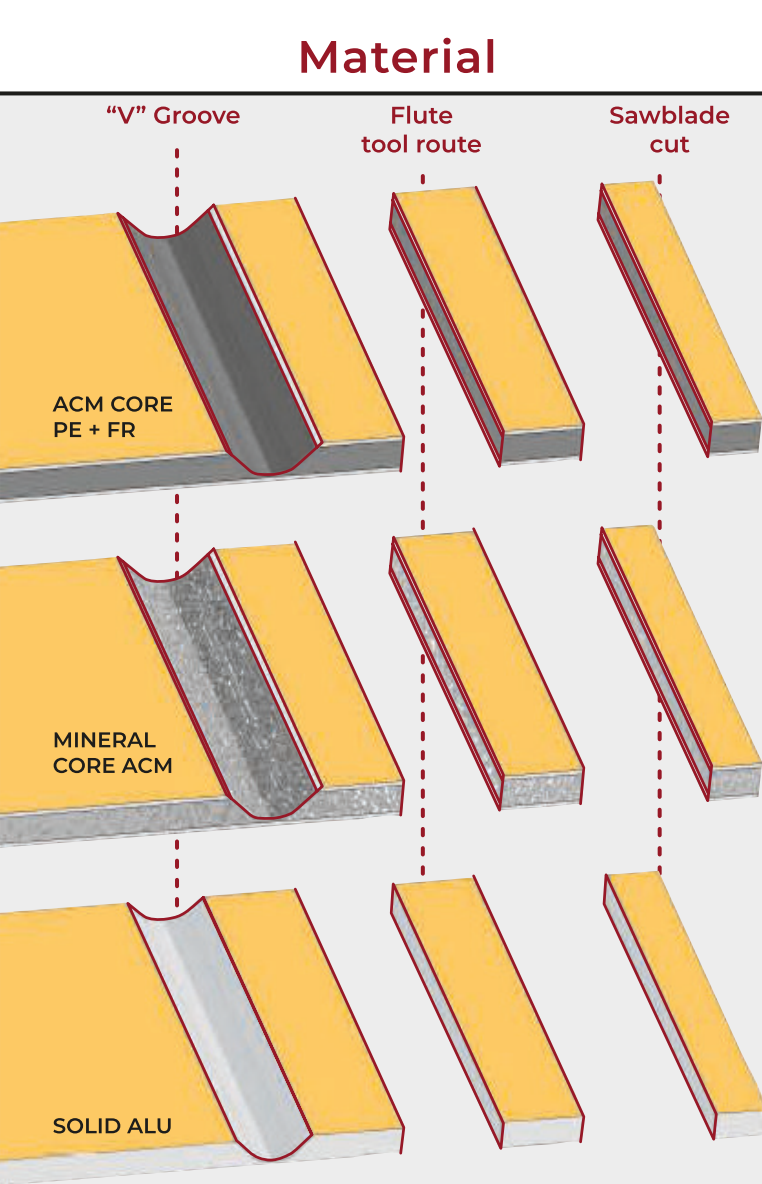

## VGroove

**VGROOVE**  
 Ø 175 mm Z 6+  
 DIAMOND (Opt)

**Processing speed**  
 up to ca. **50 mt/1'** - 1968 IPM (ACM core PE + FR)  
 up to ca. **15 mt/1'** - 590 IPM (Mineral core ACM)  
 up to ca. **10 mt/1'** - 393 IPM (Solid Alu)

**AGGREGATE WITH VGROOVE WHISPERCUT®**  
 Ø 125 mm Z 5+5 (Opt)

**Processing speed\*:**  
 up to ca. **30 mt/1'** - 1181 IPM (ACM core PE + FR)  
 up to ca. **12 mt/1'** - 472 IPM (Mineral core ACM)  
 up to ca. **8 mt/1'** - 314 IPM (Solid Alu)



## Flute tool

WITH SUPERIOR COATING BY CROWN NORGE



**Processing speed\*:**  
 up to ca. **16 mt/1'** - 630 IPM (ACM core PE + FR)  
 up to ca. **5 mt/1'** - 196 IPM (Solid Alu)



**Processing speed\*:**  
 up to ca. **10 mt/1'** - 393 IPM (ACM core PE + FR)  
 up to ca. **6 mt/1'** - 236 IPM (Mineral core ACM)  
 up to ca. **4 mt/1'** - 157 IPM (Solid Alu)

## Circular sawblade

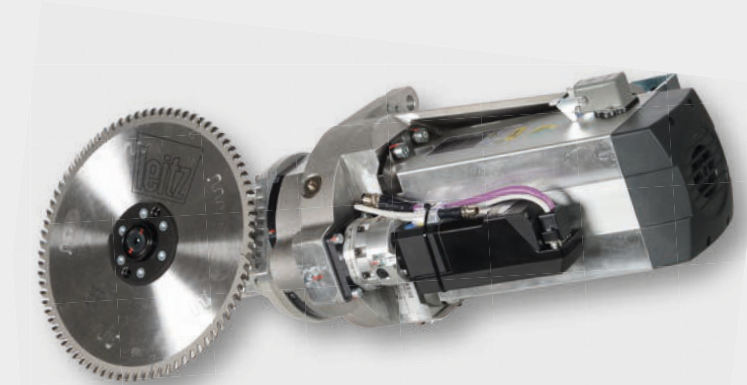

**Processing speed\* ø 200 mm:**  
 up to ca. **50 mt/1'** - 1968 IPM (ACM core PE + FR)  
 up to ca. **20 mt/1'** - 788 IPM (Mineral core ACM)  
 up to ca. **10 mt/1'** - 393 IPM (Solid Alu)

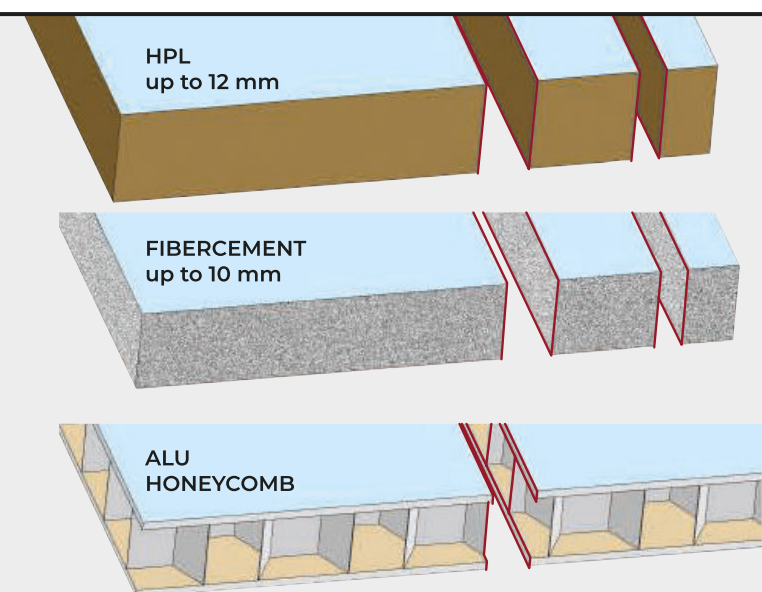

**Processing speed\*:**  
 up to ca. **6 mt/1'** - 236 IPM (HPL)  
 up to ca. **6 mt/1'** - 236 IPM (Fibercement)



**Processing speed\* ø 200 mm:**  
 up to ca. **10 mt/1'** - 393 IPM (HPL)  
 up to ca. **15 mt/1'** - 590 IPM (Fibercement)  
 up to ca. **30 mt/1'** - 1181 IPM (Alu Honeycomb)

\* Indicative speeds for an optimal quality/duration ratio

# SAFE AND CLEAN

## Double dust collection (flute tool - aggregate)

- Swarf collection for flute tool routing
- Numerical Control axis positions swarf collection main hood
- Swarf collection whatever the direction of the aggregate

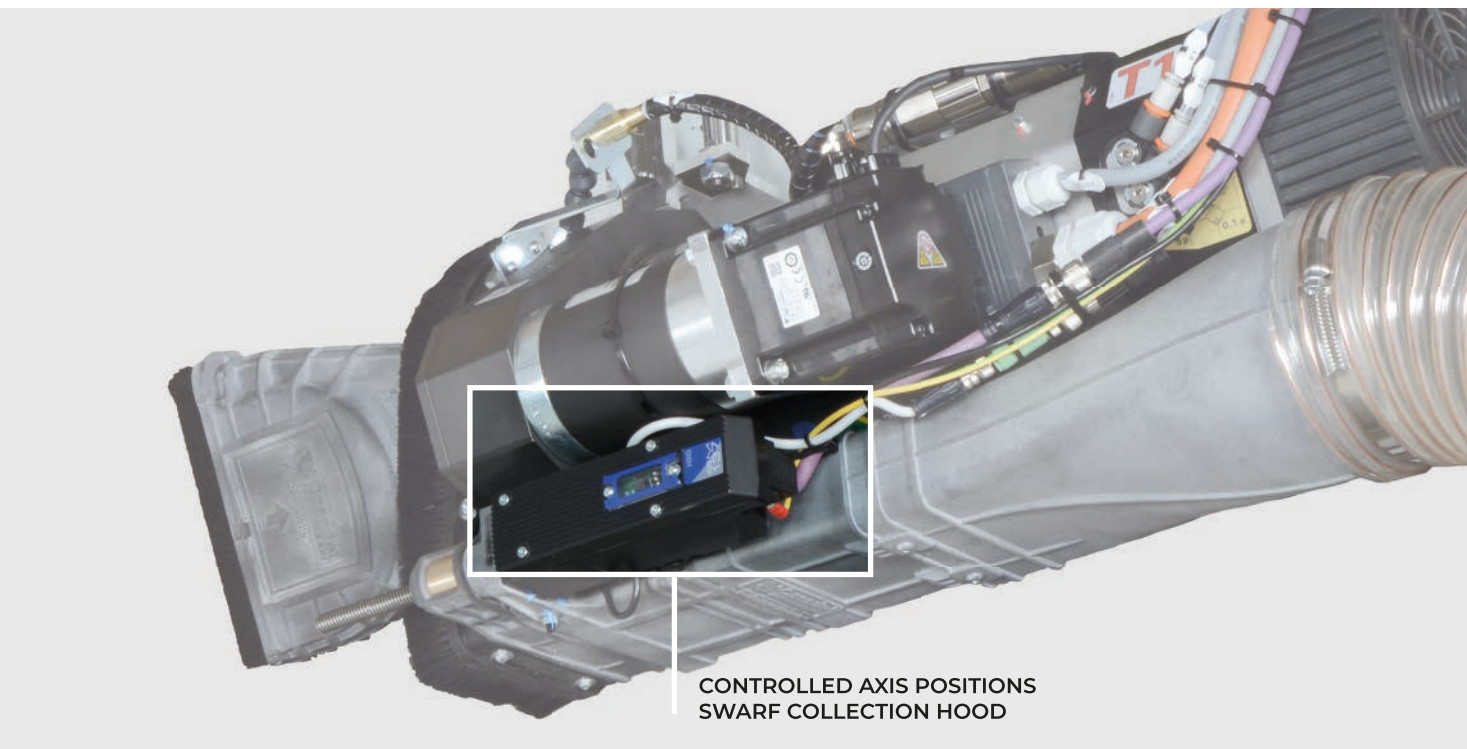

## VGROOVE Unit Dust Collection

- Collection of fine dust while processing fibercement or HPL
- Protection against sudden ejection
- Adjusts to all facade panels

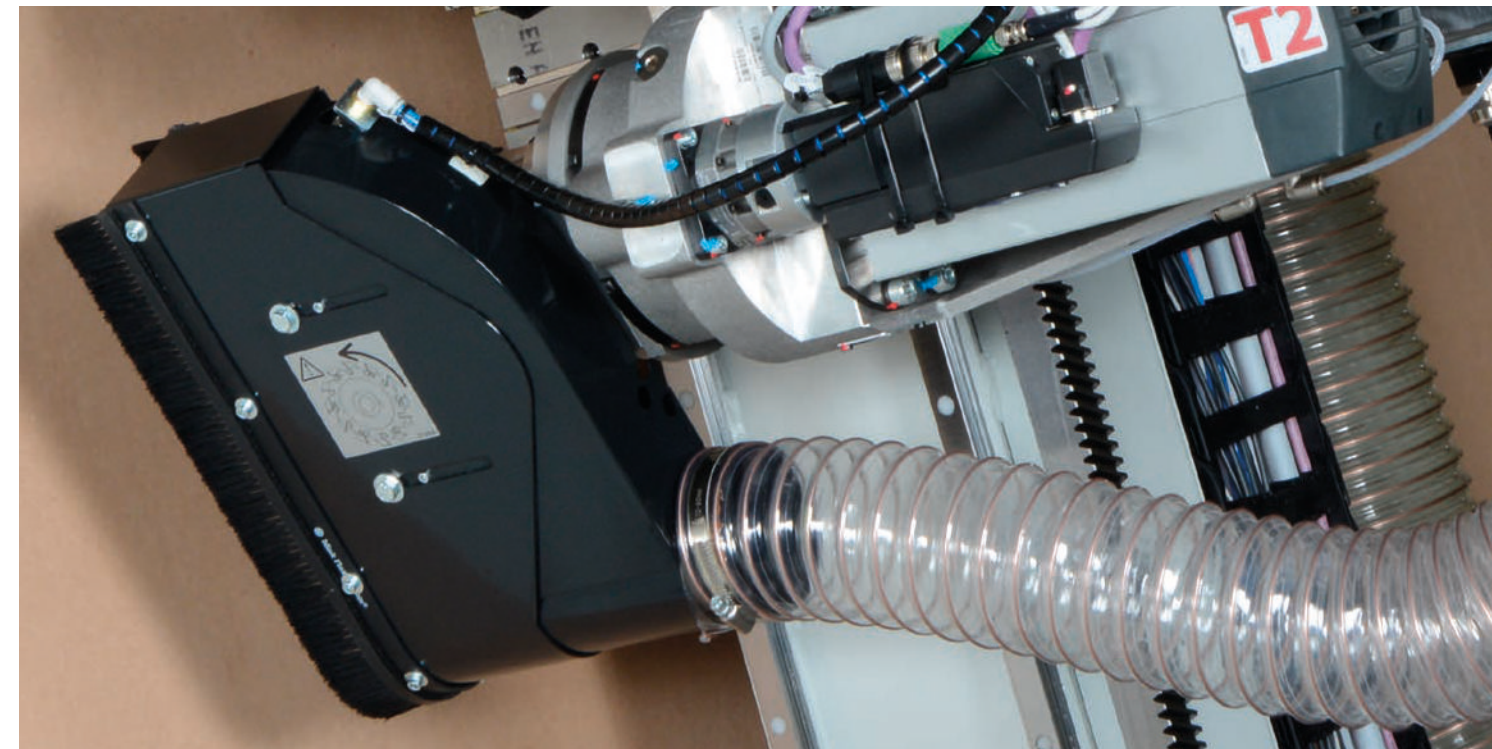

## Swarf collection hood with multiple positioning during processing (PATENTED)

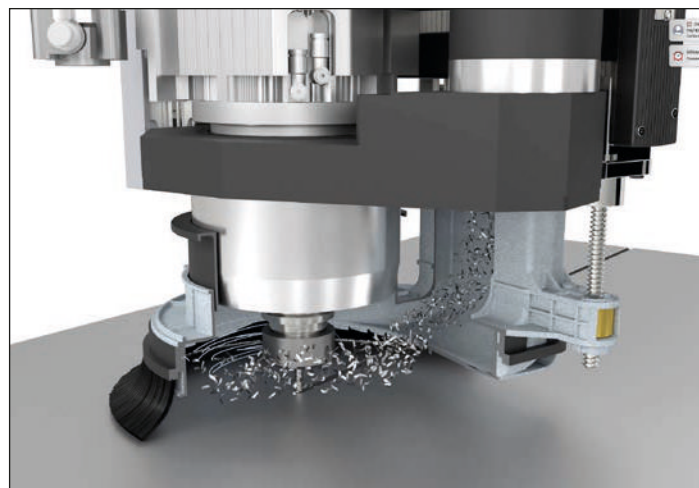

PROCESSING WITH FLUTE TOOL

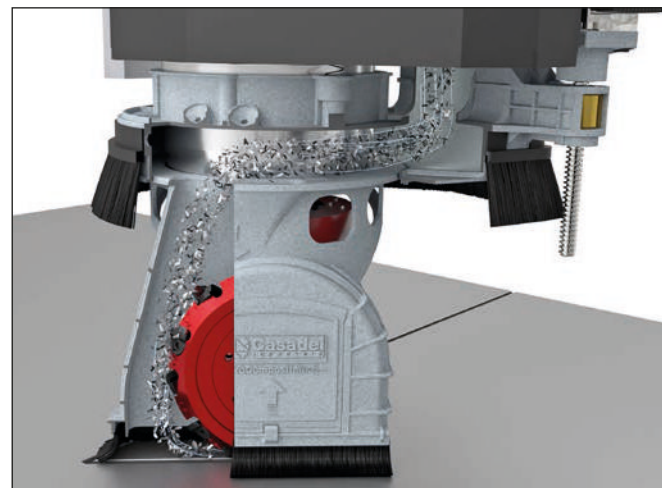

PROCESSING WITH AGGREGATES

## NO RISK OF DUST INHALATION!



V-GROOVING ON ACM



HPL CUT



FIBERCEMENT CUT



# VERTICAL STRUCTURE



- Table flatness is guaranteed by machining the frame vertically
- The robust vertical design absorbs more vibration which results in less chatter marks during processing that will extend tool life
- Operator's safety is increased by side protection barriers and a safety light curtain

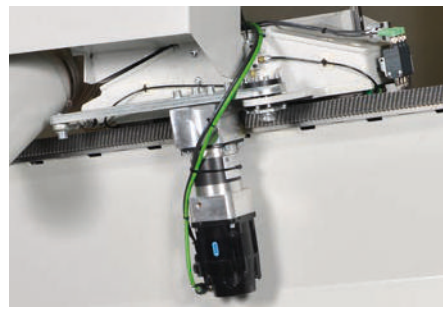

**Top gantry motor**



**Electrical cabinet and control panel integrated into the vertical frame**

- CE compliant
- Main components Made in Germany and Japan
- Perfectly accessible and free from electromagnetic disturbances

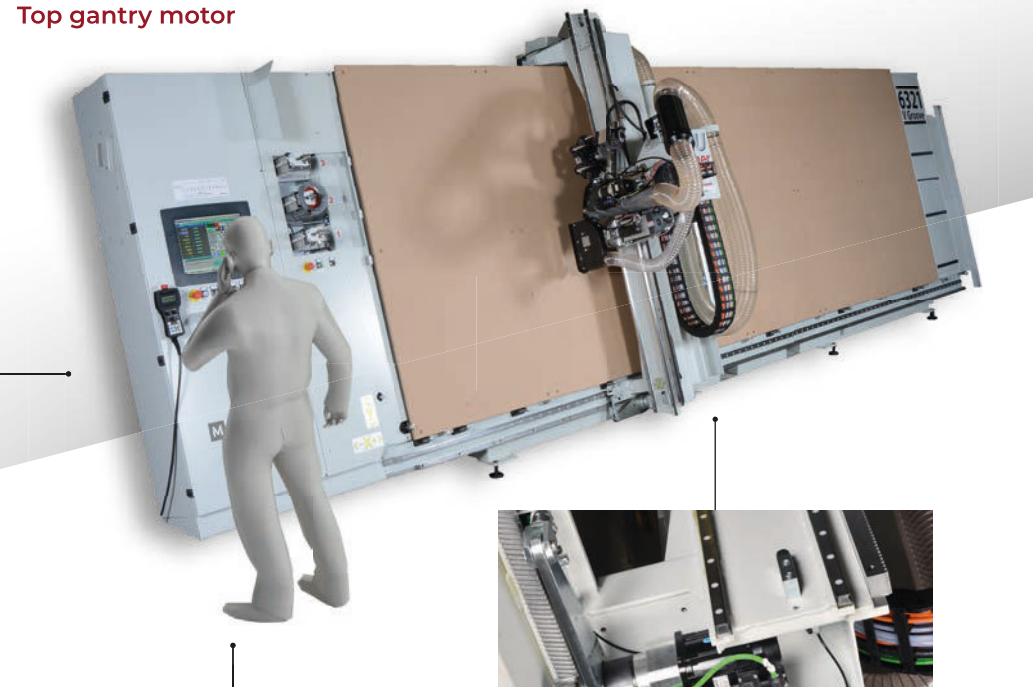

**Ergonomic access to the work table**

- Optimal control of the whole process
- Total view of the machine
- High level of safety for the operator

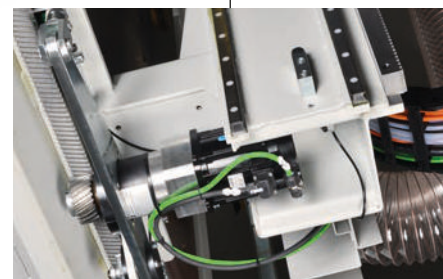

**Lower gantry motor**



**Hand-held remote control (Opt)**

- 4 lines and 16 characters
- Axis manual control "JOG"
- Speed control "Override"



**Automatic presetter for tool length**

- Fully automatic
- Measurement tolerance  $\pm 0.02$  mm  $\pm 0.0007$  In



**Industrial numerical control**

- Up to 7 axis controlled (X,Y,Z interpolating)
- 17" LCD colour monitor
- Ethernet connection, USB, mouse



**Origin pop-up stops**

- Bearing for easy panel sliding
- Pneumatic control with safety sensor connected to PLC

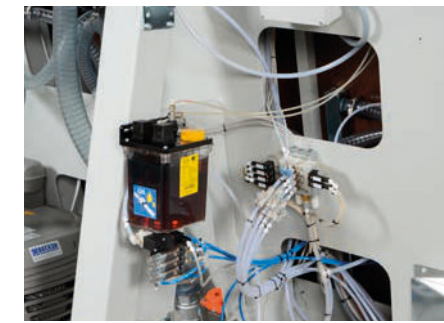

**Automatic lubrication for linear guides**

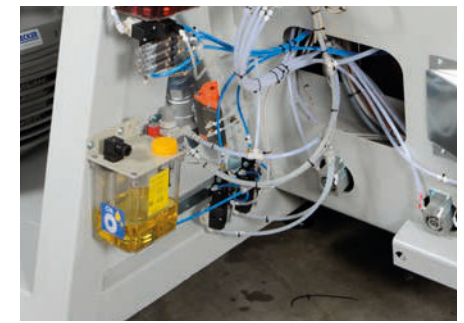

**Automatic lubrication for tools**

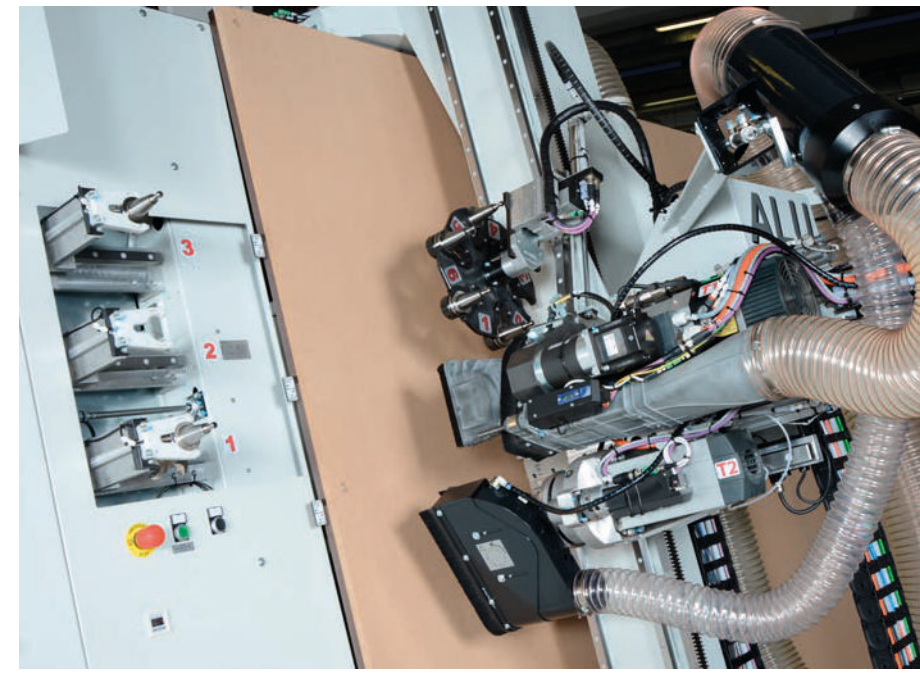

**Tool changer**

- 9+1 available tools with automatic change
- Cone presence sensor

# DIMENSIONS

## Technical features

	ALU Ranger VGroove <b>4221</b>	ALU Ranger VGroove <b>6321</b>	ALU Ranger VGroove <b>10121</b>
Working table (mm) Working table (imperial)	X 4200 - Y 2100 - Z 90 X 14' - Y 6' 11" - Z 3' ½	X 6300 - Y 2100 - Z 90 X 20' 8" - Y 6' 11" - Z 3' ½	X 10100 - Y 2100 - Z 90 X 33' 2" - Y 6' 11" - Z 3' ½
Panel holding, vacuum by working table with MDF sacrificial board (selection by PLC)	6 zones AUTO	8 zones AUTO	12 zones AUTO
Panel holding vacuum by zones combinations	24	32	48
Vacuum pump	1 x 250 m <sup>3</sup> /h 1 x 147 Cfm	2 x 250 m <sup>3</sup> /h 2 x 147 Cfm	4 x 250 m <sup>3</sup> /h 4 x 147 Cfm
Axis speed (Rapid)	X 50 - Y 30 - Z 10 mt/min X 164' - Y 98' - Z 32' ft/1'		
Electrospindle R8A	8 Kw - collet ER32 up to 24000 g/min		
Automatic tool changer - head side TC6L	Rotary tool changer - 6 positions - ISO30 cones		
Automatic tool changer - working table side (for aggregates)	3 Std		
Routing head VGroove V175	5 Kw up to 8000 g/min		
Total power	min 17 KW max 27 KW	min 22 KW max 32 KW	min 35 KW max 45 KW
Max weight of panel under process	ca. 250 Kg ca. 550 Lb	ca. 350 Kg ca. 772 Lb	ca. 500 Kg ca. 1102 Lb
Total weight	ca. 2700 Kg ca. 5950 Lb	ca. 3600 Kg ca. 7930 Lb	ca. 5000 Kg ca. 11020 Lb

We reserve the right to make modifications. The machine can include equipment not shown in standard version.  
For photographic reasons some units are without protections. The use of machine must be made with all protections installed.

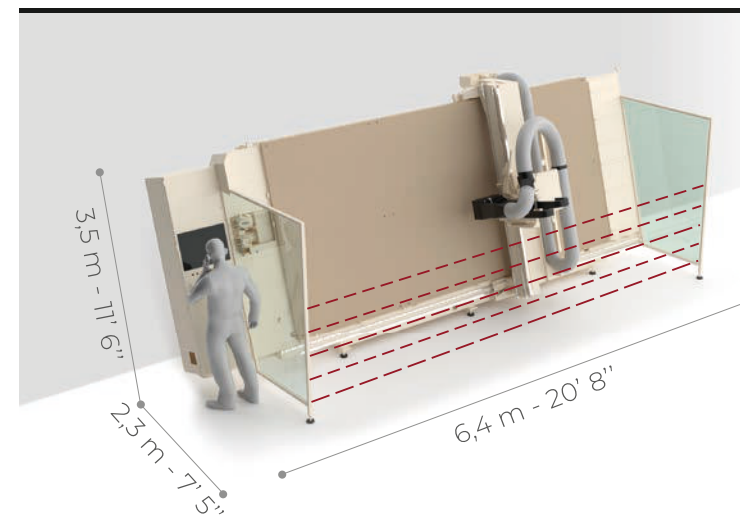

## ALU Ranger **4221 VGroove**

WORKING TABLE  
X 4200 - Y 2100 - Z 90 mm  
X 14' - Y 6' 11" - Z 3' ½

SURFACE OCCUPIED  
L 6,4 m - P 2,3 m - H 3,5 m  
L 20' 8" - P 7' 5" - H 11' 6"

SURFACE OCCUPIED  
WITH ALU LOADER  
L 11,1 m - P 2,3 m - H 3,5 m  
L 36' 41" - P 7' 5" - H 11' 6"

WORKING TABLE SURFACE  
8,8 m<sup>2</sup> - 95 sq ft

SURFACE OCCUPIED  
ca. 15 m<sup>2</sup> - 161 sq ft

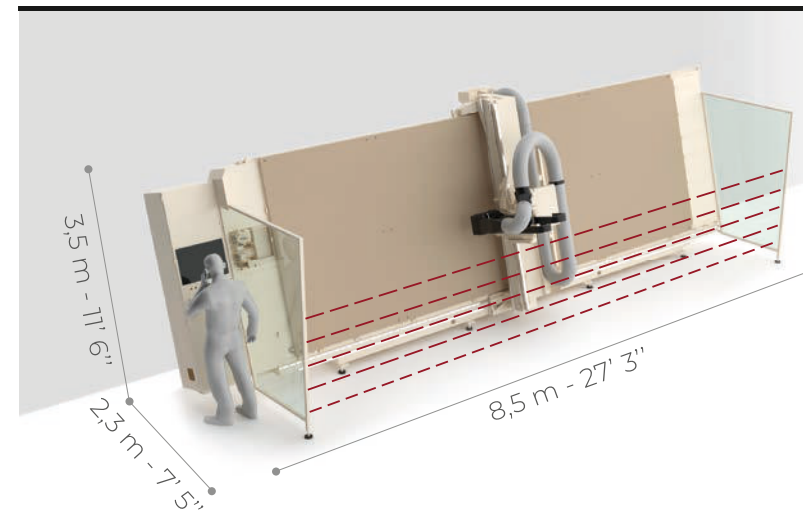

## ALU Ranger **6321 VGroove**

WORKING TABLE  
X 6300 - Y 2100 - Z 90 mm  
X 20' 8" - Y 6' 11" - Z 3' ½

SURFACE OCCUPIED  
L 8,5 m - P 2,3 m - H 3,5 m  
L 27' 3" - P 7' 5" - H 11' 6"

SURFACE OCCUPIED  
WITH ALU LOADER  
L 15,3 m - P 2,3 m - H 3,5 m  
L 50' 2" - P 7' 5" - H 11' 6"

WORKING TABLE SURFACE  
14 m<sup>2</sup> - 151 sq ft

SURFACE OCCUPIED  
ca. 19,5 m<sup>2</sup> - 210 sq ft

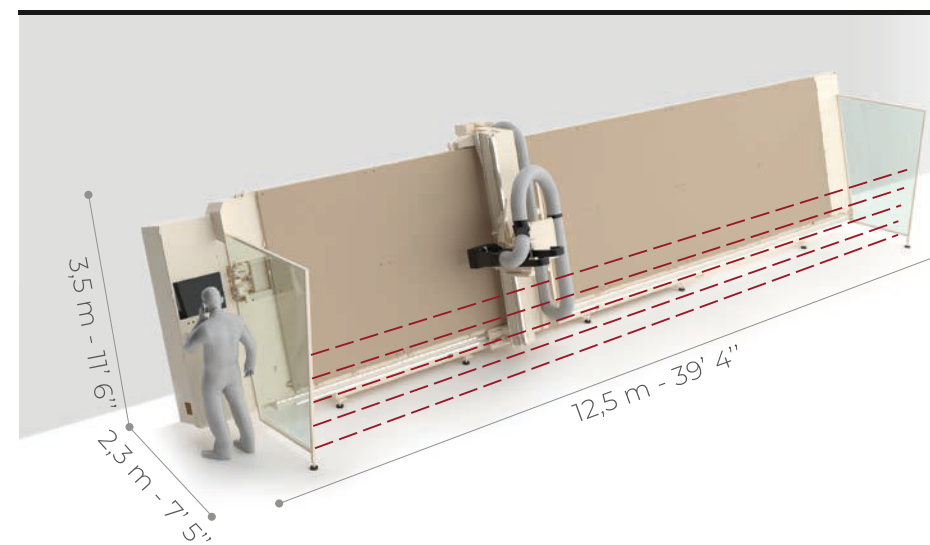

## ALU Ranger **10121 VGroove**

TABLE SURFACE  
X 10100 - Y 2100 - Z 90 mm  
X 33' 2" - Y 6' 11" - Z 3' ½

SURFACE OCCUPIED  
L 12,5 m - P 2,3 m - H 3,5 m  
L 39' 4" - P 7' 5" - H 11' 6"

SURFACE OCCUPIED  
WITH ALU LOADER  
L 22,9 m - P 2,3 m - H 3,5 m  
L 75' 13" - P 7' 5" - H 11' 6"

WORKING TABLE SURFACE  
21 m<sup>2</sup> - 226 sq ft

SURFACE OCCUPIED  
ca. 28,8 m<sup>2</sup> - 310 sq ft

# MURATORI MACHINES



For three generations the Muratori family have been manufacturing machines for the wood processing industry, while evolving and diversifying its production to include machines for processing aluminium panels and composite materials. Suitable for architectural façade cladding, the transport industry, interior design and sign-making sectors.

**Antonio Muratori** received his training at and became an expert in the family business, where, thanks to almost three decades of experience, he has conceived, designed, and built the technology for automated handling and processing of composite panels.

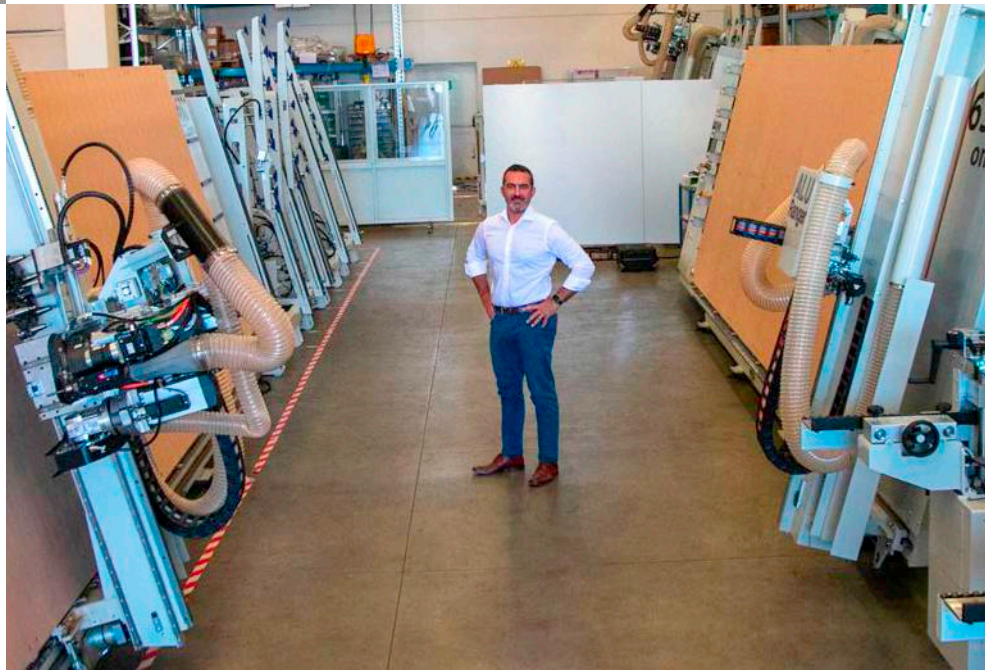

## About us

Muratori Machines was established and followed in the footsteps of the tradition and know-how acquired by Casadei Industria ALU. It now has a robust industrial organisation where, under the guidance of Antonio Muratori, its technologies, machines and CNC for the processing of ACM, solid aluminium, aluminium honeycomb, HPL and fibre cement panels are designed and built. Professionalism, expertise and with an open mind making it possible to meet the needs of customers. Introducing automation to the world of composite panel processing, while responding to production requirements. Totally committed the team at Muratori Machines focuses on innovation and quality with a view to finding ground-breaking solutions and revolutionising design and manufacturing models.

## CNC machining innovation incorporating a Vertical Table

The innovation factor finds full expression in the vertical positioning of the working table. Thanks to automated panel loading, positioning and offloading systems, the integrated work cell achieves exceptional productivity levels.



## The advantages of a vertical system assure tangible results

- Reduced space requirements
- Quality assurance during processing
- Enhanced ergonomics and safety
- Single operator for process control



# VISION

*We aim to break the status quo and revolutionise traditional design and manufacturing methods, with a view to maximising ergonomics, operability, and ease of use.*

# MISSION

*We facilitate traditional production cycles for our customers. Using innovative technology within everyone's reach automating processes, involving composite material processing.*



# THANK YOU



On behalf of our employees and partners around the world, thank you for your interest in Muratori Machines.

Since the first ACM panel routed in 2006 we have one mission: to create and provide the best composite material panel handling and fabricating experience possible.

Muratori Machines have invested for the long term, consistently dedicating resources to researching and developing innovative panel routers, handling technologies and services that provide value to our customers.

This approach has culminated in our range: the Alu Ranger, Alu Loader, Double Loader, Off Loader, Alu Folder, Alu Bender, Alu Doubler.

In short, we have revolutionized the concept of panel routing and with it, the business of the panel fabricating industry.

Thank you again for your interest in exploring Muratori Machines.

We are ready to improve your business.

Sincerely,  
**Antonio Muratori**  
CEO  
*Muratori Machines*

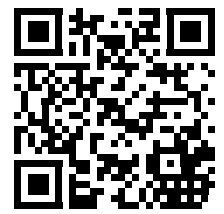
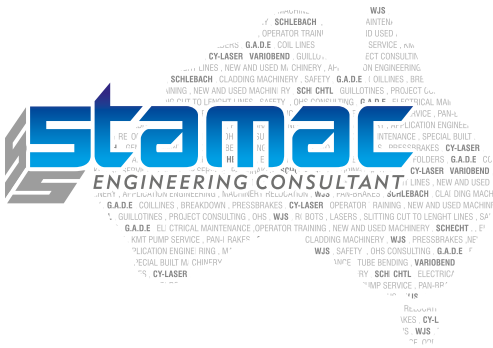

**STAMAC ENGINEERING PTY LTD**  
59 Naxos Way, Keysborough, Victoria 3173  
Phone / Fax: +613 9769 3988      Mobile: +61451 665 316  
Email: [peter@stamac.com.au](mailto:peter@stamac.com.au)      Web: [www.stamac.com.au](http://www.stamac.com.au)