

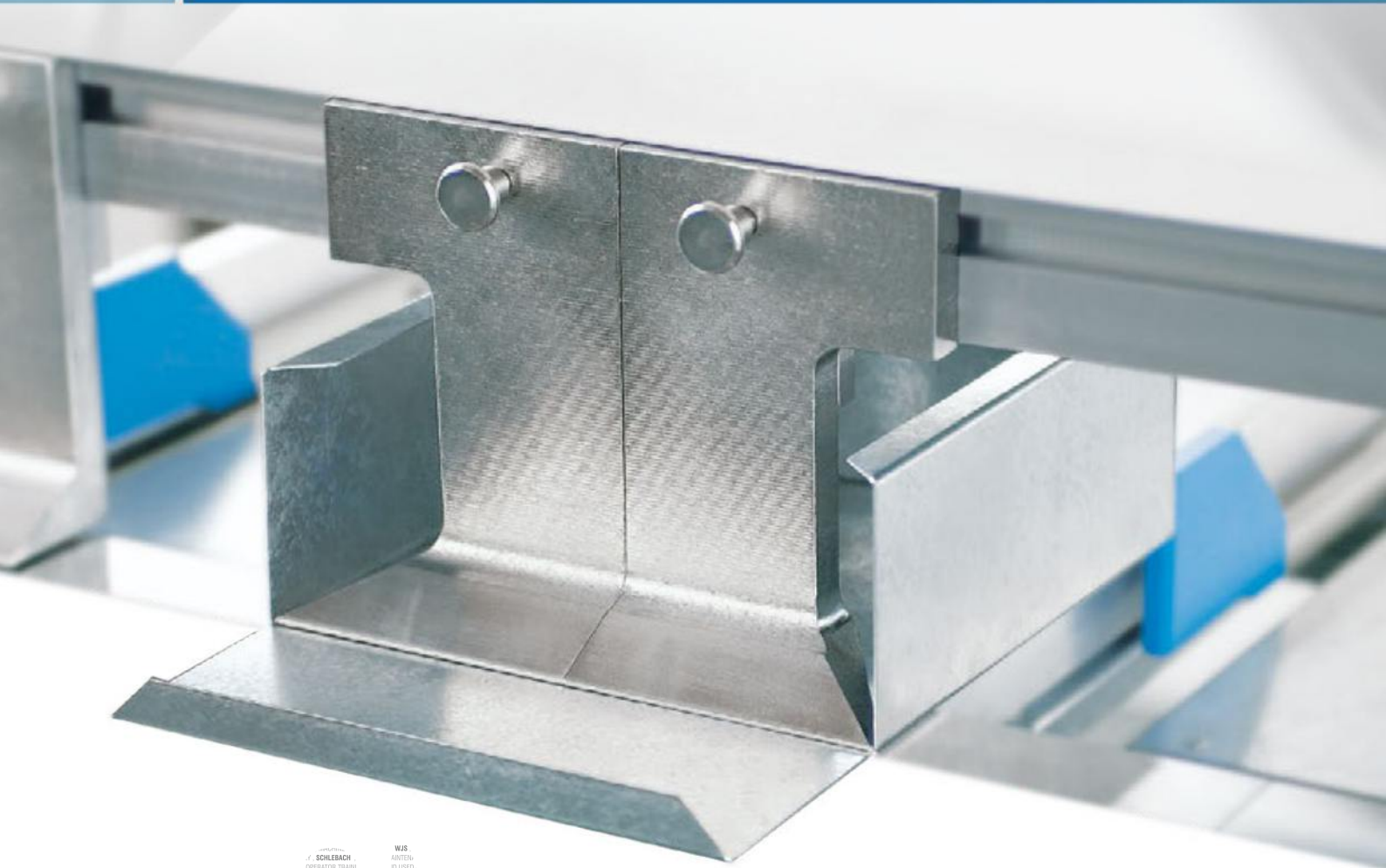

MANUAL & MOTORIZED SEGMENT BENDING

MACHINES FOR COMPLEX FORMS IN SHEET METAL PROCESSING



standac
ENGINEERING CONSULTANTS

WJS
ANTEN
DI USED
SERVICE, MA
ECT CONSULT
ON ENGINEER
CYLASER, VARIOBEND, GULLU
G.D.E. COLLINES
G.D.E. COLLINES
SCHLEBACH, CLADDING MACHINERY, SAFETY, G.D.E. COLLINES, BRE
WING, NEW AND USED MACHINERY, SCHECHTL, GUILLOTINES, PROJECT C
WORLD TO LIGHT LINES, SAFETY, DISCONSULTING, G.D.E. ELECTRICAL MA
CYLASER, VARIOBEND
G.D.E. COLLINES, BREAKDOWN, PRESSBRAKE, CYLASER, OPERATOR TRAINING, NEW AND USED MACHIN
GUILLOTINES, PROJECT CONSULTING, OHS, WJS, ROBOTS, LASERS, SLITTING CUT TO LIGHT LINES, SP
G.D.E. ELECTRICAL MAINTENANCE, OPERATOR TRAINING, NEW AND USED MACHINERY, SCHECHTL, I
KMT PUMP SERVICE, PAN-BRANK
CLADDING MACHINERY, WJS, PRESSBRAKES, J
"LOCATION ENGINEERING, W
"MEDIAL BUILT MACHINERY
CYLASER
WJS
TUBE BENDING, VARIOBEND
RY, SCHECHTL, ELECTRIC
"NEW SERVICES, PAN-BR
"18
RESERVING
MES, CYL
S, WJS
"2 010



WE WANT TO CONTRIBUTE TO YOUR SUCCESS

PIONEERING SPIRIT AND INNOVATION BORN OF PASSION FOR THE SHEET METAL TRADE.

WE TRULY GO THE DISTANCE TO HELP YOU GET AHEAD

You know it's true because you have experienced it yourself, just like generations before you: we listen to you, our customer. This is how we get our ideas and develop our machines which have made the daily work of sheet metal workers in industry and trade easier and more efficient for decades.

Since our foundation in 1910 as a simple blacksmith shop, this pioneering spirit has driven us forward, always with an eye to creating value for our customers. Before the invention of bending technology, this standard led to countless innovations including time-efficient mobile data transfer of completed profiles from the job site directly to the machine.

The same is true for segment bending. Well over 10.000 sheet metal workers currently use our segmented rail system solutions to produce complex forms in a logical work cycle. A head start is created by exchanging knowledge - both sides profit.

LOYALTY MEANS QUALITY

Very high quality, incredible durability, and outstanding reliability – that's what generations of sheet metal workers all over the world have said about our products. While we're extremely honored by these words, they also motivate us to keep our "Made in Germany" seal of quality at a high level.

With solid commitment to our location, we produce and assemble numerous machine parts exclusively in Germany – most of them in Bavaria. This strong connection to regional partners and suppliers is a foundation for quality. This type of thinking and customer satisfaction is what has made Schechtel the world's leading manufacturer of bending machines and shears for thin sheet processing.

THANK YOU FOR CHOOSING SCHECHTEL

Schechtel is a family business, owner-operated for over 100 years and now in its fourth generation. A combination of healthy growth and strong economic stability means that our corporate development strategy is geared towards the long haul.

That's why we not only invest in technology, but also in creating an atmosphere of positivity and trust as well as in the knowledge of our employees. Because ultimately, the thing that truly helps a business get ahead is the commitment and competence of the people who determine its path. Satisfied employees are more committed, which our customers can observe daily.

Maria Schechtel

Maria Schechtel
Managing Director



PRODUCT FINDER

THE RIGHT COMBINATION OF WORKING LENGTH, BENDING PERFORMANCE AND PRODUCTION REQUIREMENTS WILL HELP YOU FIND THE IDEAL SEGMENT BENDING MACHINE.

1. DO YOU PRODUCE CLOSED FORMS, BOXES, CASSETTES AND THE LIKE AT THE JOB SITE?
2. DO YOU DO A LOT OF MANUAL PRODUCTION ON THE SHOP FLOOR?
3. DO YOU NEED MORE FREE SPACE FOR DIFFERENT TYPES OF COMPLEX FORMS?

- Specialist for mobile segment bending at the job site:
→ **TBS** (page 7)
- Experienced professionals for individual workpieces, prototypes, special structures and sporadically recurring small series:
→ **UK, UKV** (pages 8 – 9)
- For more free space of movement in manual segment bending:
→ **UKF** (page 10)
→ **SB** (page 11)

Areas of application	Segment bending				
	Job site	Shop floor			
Machine type	TBS	UK	UKV	UKF	SB
Drive type	manual				
Working length					
2x550					1.00
1040	0.63	1.50	2.00	1.50	
1250	0.63	1.25	1.75	1.50	
1540			1.50	1.50	
2040			1.00	1.00	
Control systems	manual				

Bending capacity for steel 400 N/mm², based on standard segment heights

SEGMENT BENDING

Segment bending machines are particularly cost-effective; they produce closed forms easily, precisely and also save time as well as comfortably manage individual orders and small series at the job site or on the shop floor.

JOB SITE

Mobile, comfortable and manageable like no other. The **TBS** is your best bet for precise segment bending at every area of the job site.

SHOP FLOOR

Segment bending on the shop floor: that is what our manual **UK** models, proven thousands of times over, stand for.



PANEUM
WUNDERKAMMER DES BROTES

MASTERFUL VARIETY OF FORMS IN ROOFS AND EXTERIORS

TRICKY AND COMPLICATED FORMS MADE EASY: WITH A SEGMENT BENDING MACHINE,
YOU CAN GET THE PERFECT FORM FOR BOXES, CASSETTES, WINDOW SILLS AND THE LIKE.

TBS



UK



UKV



UKF



SB



CLEVER SEGMENT BENDING – COMPLEX FORMS MADE EASY

EASY AND SAVES TIME. NO TOOLS NEEDED.

COMPLEX FORMS MADE EASY - IN ONE WORK CYCLE WITHOUT CONVERSION TIME

Segment bending machines are equipped with segmented rail system. The bending rail consist of individual segmented tools. Clever combination and the free space between the segmented tools make it possible to bend workpieces on all sides. You can use it to produce tricky and complicated forms quickly and easily.

You can lay out several segment stations next to each other and implement successive work steps rationally and without conversion time, all in one machine and in one work cycle.

BENEFITS

THE QUICK CLAMPING SYSTEM INCREASES PRODUCTIVITY IN SECONDS

The manual bending machines from Schechtl are equipped standard with the patented quick clamping system on the clamping, lower and bending beam. The concept makes it very simple to rearrange tools. Tried and tested thousands of times in practice. As you neither need tools or screws, you gain valuable time and increase productivity.

THE VARIETY OF FORMS IS ENORMOUS

Elaborate box forms, special forms, samples and window sills are easy to produce in an efficient way.

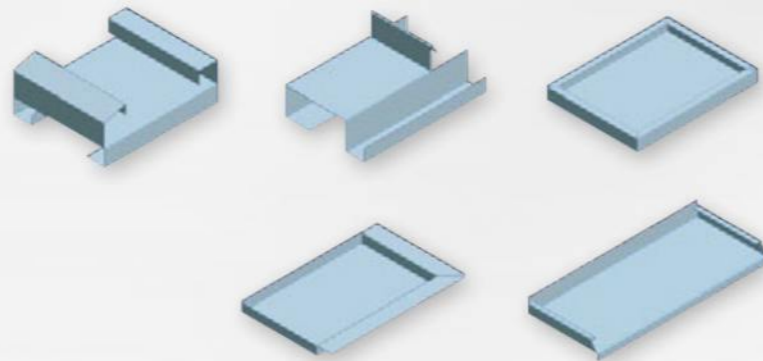

MOBILE LIGHTWEIGHT AT THE JOB SITE

AGILE AND MOBILE. EASY HANDLING.

SEGMENT BENDING

JOB SITE



BENEFITS

BOXES, CASSETTES AND THE LIKE IN ONE WORK CYCLE

- rational and productive – all segments can be adjusted without tools
- The TBS masters even 25 mm and 35 mm rollformed seams for eaves and ridge folds
- with the TBS, sheet metal workers avoid any "surprises" at the job site and can work completely self-sufficiently in profile production

CONVENIENCE

EFFORTLESS ON THE JOB SITE

- 1 worker alone can easily transport and operate the TBS
- The TBS (without X-shaped support stand) can be installed on a workbench or in a construction vehicle
- Foldable X-shaped support stand with rollers and handle (available as an option)
 - Stable and convenient to transport
 - Simply pull it behind you like a roller suitcase
- Reduce transport weight – segments are transported in a separate box where they are stored safely and optimally protected



TECHNICAL FEATURES

- all beams have 40mm free space of movement
- the clamping beam only has a 45 degree flat slope – this offers additional free space for refined seamed profiles with long limbs
- the roller shear is a useful accessory for cutting sheets directly on the machine (optionally available)

TRANSPORTABLE. JOB SITE. SEGMENT BENDING.

Your area of application spells out the TBS. The smallest of the manual segment bending machines in the Schechtl range is huge when it comes to its flexibility on the job site.

Thanks to its small dimensions, you can easily move the TBS on the job site, as well as between floors, on scaffolding and in small areas.

TBS



TBS with foldable X-shaped support stand (optionally available)

TWO, WHO LIKE TO SHARE - STRONG SPECIALISTS FOR THE SHOP FLOOR

THE SPECIALISTS FOR TRICKY TASKS.

HIGH QUALITY FOR SPECIAL FORMS

Two manual bending machines master tricky special designs as well as everyday supplemental bends on workpieces, boxes, cassettes requirements.

The **UK** and the stronger **UKV** are your specialists for closed special forms. The segments are cleverly positioned, and several work steps are completed without conversion time. The rational work flow is maintained while conversion of the motorized machines becomes unnecessary.

The **UK** and **UKV** are ideal for single-piece production and small series as well as prototype construction in the trade sector.

proven
10.000
times

BENEFITS

ADJUSTMENT WITHOUT TOOLS - A HUGE ADVANTAGE FOR SAFETY, PRECISION AND SPEED

- clamping, lower and bending beam with patented quick clamping system is standard
- combine and rearrange any segments in a flash – without using tools and screws
- intelligent segment combination of several work steps can be executed in a rational manner without conversion time
- take out individual tools - this creates free space between the segments for closed workpieces



High clamping beam segments



Adjust bending angle with scale and lever



Use storage box as work surface (without back gauge)

TECHNICAL FEATURES

COUNTLESS PRACTICAL DETAILS MAKE EVERYDAY WORK EASIER

- Adjustments without tools – a huge advantage for safety, precision and speed.
- lower bending beam with hand wheel and scale
- set clamping beam pressure with a lever
- equipped with wheels, the **UK** (standard) and the **UKV** (optionals) - can be set up at any point in your production
- standard foot pedal – hands-free work throughout the entire production process
- segments not currently in use can be easily stored in a storage tray located above the clamping beam
- the storage box for all segments is located in a space-saving location under the back gauge, or can be used as a tool tray in the standard model

ACCESSORIES

OPTIONAL ACCESSORIES

- high clamping beam segments 140 mm + 160 mm (**UK + UKV**) 180 mm (**UKV** only) (Standard = 100 mm)
- clamping bar inserts with 2 mm and 3 mm radii, zinc and aluminum can be more reliably bent thanks to the larger curve
- various back gauge systems
- inserts for producing windowsills
- roller shear
- wheels with chassis (**UKV**)



UK/UKV back gauge (aluminum T-slot)



UKV back gauge (spur rack)

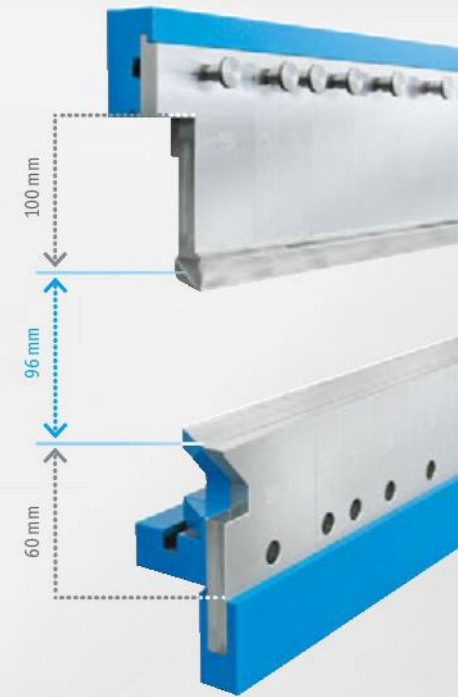

UK POWER



UKV MORE POWER



THE ONE WITH EXTRA HIGH SEGMENTED TOOLS – FREE SPACE XXL

DOUBLE AMOUNT OF FREE SPACE FOR LARGE SPECIAL FORMS.

ALL THE QUALITIES OF THE UKV – ONLY MUCH BIGGER! NEW PEAK PERFORMANCE IN MANUAL SEGMENT BENDING.

The "F" stands for "flexible". With larger dimensions and countless benefits, the **UKF** is the perfect pick: the **UKF** has room for 160mm- and 180mm-high segmented tools on the clamping beam. The segmented tools of the lower and bending beam are 120mm-high, these are **100% more free space**. The working height was increased by 160mm compared to the **UKV**. Large-format sheets can be processed with better ergonomics.

BENEFITS

SAVE MONEY AND MAKE PRODUCTION MORE CONVENIENT:

The extreme free space makes it possible for sheet metal workers to create larger closed forms. In addition, there is more flexibility and throughput in the workflow.

Higher segments are often special tools on other machines. What needs to be manufactured separately on those machines is standard with the **UKF**.

The **UA 125** universal back gauge table expands the spectrum for recurring profiles in particular. The back gauge table is equipped with wheels and can be used on several **UK** models.

ACCESSORIES

OPTIONAL ACCESSORIES

- 180mm-high segments for the clamping beam (standard = 160mm)
- segments for the clamping beam with 2mm or 3mm radii, zinc and aluminium can be bent thanks to the larger curve
- **UA 125** universal back gauge table
- rolling device (wheels) for **UKF**



Special series in a work cycle, mobile **UA 125** universal back gauge table for sheet control

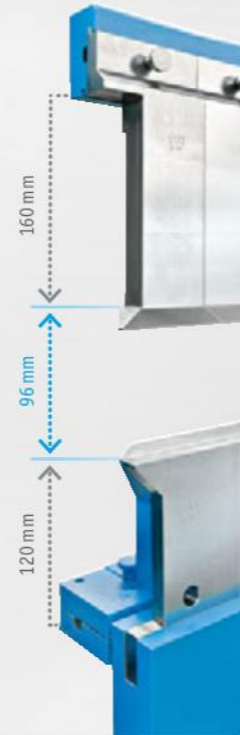

UKF



THE SHINGLE SPECIALIST FOR SMALL AND LARGE SERIES

FAST AND EFFECTIVE. BRILLIANTLY EASY.

SEGMENT BENDING

SHOP FLOOR

BENEFITS

SHINGLES, RHOMBUSES AND THE LIKE ON TWO SIDES IN ONE OPERATION

- formats such as shingles or rhombuses can be processed in dimensions of 20-50 cm bending length
- special round rails with a 1.25 mm radius on both clamping beams enables the bending of hems in one operation

CONVENIENCE

EASY OPERATION

- one worker alone can operate the machine through the unique bending beam segments with an ergonomic working height and practical foot pedal
- precise and repeatable positioning of the flat patterns with the standard back gauge
- due to the special design, 24 conventional working steps are reduced to only 8 – you save approx. 70% of your time

TECHNICAL FEATURES

- two accurate 180° edges in one operation
- hems without additional pressing
- repeatable work processes with two bends on two sides in one operation
- 100 mm free space on upper beam with special round rails in radius 1.25 mm
- segmented lower beam with 20 mm free space

SERIES PRODUCTION IN THE SEGMENT BENDING FIELD

The advantages of the **SB** speak for themselves

- ✓ manually
- ✓ mobile
- ✓ cost-efficient
- ✓ repeatable accuracy



SB



Real beauty come to light, and the metalworker makes it happen

Reliable handling for all segment bending requirements

Metalworkers love reproducing beautiful forms

Historical treasures are well protected by first-class formed sheets

MASTERFUL EXTERIORS WITH CLASSIC DESIGN

CONNECTING TRADITION AND MODERNITY MEANS HAVING HIGH STANDARDS FOR SHEET METAL PROCESSING. COMPLEX SEGMENTED FORMS ARE THE DOMAIN OF THE SCHECHTL SEGMENT BENDING MACHINES.

ACCESSORIES

CONFIGURE YOUR SEGMENT BENDING MACHINE TO YOUR INDIVIDUAL REQUIREMENTS. THE OPTIONAL ACCESSORIES PROVIDE GREATER CONVENIENCE, PRECISION AND SAVES TIME AS WELL.

1 UK/UKV MANUAL BACK GAUGE WITH ALUMINUM T-SLOT



UK/UKV manual back gauge with aluminum T-slot, conical angles can also be set.

2 UKV MANUAL BACK GAUGE WITH SPUR RACK



UKV manual back gauge with spur rack and hand wheel.

3 HIGH CLAMPING BEAM SEGMENTS



For more flexibility in the production of larger closed shapes.

4 TBS X-SHAPED SUPPORT STAND: MOBILE, FOLDABLE, ROLLABLE



5 UA 125 UNIVERSAL BACK GAUGE TABLE



Sheet metal supply with freely-adjustable magnetic guide rails.

6 ROLLER SHEAR



Mobile roller shears for the TBS model.

7 STANDARD WINDOW SILL SEGMENTS



8 VARIABLE WINDOW SILL SEGMENTS



9 UKF/UKV ROLLING DEVICE (WHEELS) FOR MORE MOBILITY ON THE SHOP FLOOR



Areas of application	Segment bending											
	Job site		Shop floor									
	TBS	UK	UKV				UKF					
	100	125	100	125	100	125	150	200	100	125	150	200
	manual											
STANDARD ACCESSORIES												
Segments with quick clamping system for clamping, lower and bending beam throughout the entire working length	[Standard]											
Free space for clamping beam segments (passage height)	40 mm	40 mm	100 mm	100 mm	100 mm	100 mm	100 mm	100 mm	160 mm	160 mm	160 mm	160 mm
Free space for lower and bending beam segments (passage height)	40 mm	40 mm	60 mm	60 mm	60 mm	60 mm	60 mm	60 mm	120 mm	120 mm	120 mm	120 mm
Clamping beam opening height	45 mm	45 mm	96 mm	96 mm	96 mm	96 mm	96 mm	96 mm	96 mm	96 mm	96 mm	96 mm
Angular stop, adjustment by lever	[Standard]											
Clamping beam pressure adjustment	[Standard]											
Bending beam lowering adjustment	[Standard]											
Storage box	[Standard]											
Foot pedal/Foot switch	[Standard]											
Wheels	[Standard]											
OPTIONAL ACCESSORIES												
6 Roller shear	[Optional]											
4 X-shaped support stand	[Optional]											
1 Manual back gauge, 500 mm with aluminum T-slot	[Optional]											
2 Manual back gauge, 500 mm with spur rack	[Optional]											
5 UA 125 universal back gauge table	[Optional]											
7 Window sill segments (standard)	[Optional]											
8 Window sill segments with variable length	[Optional]											
Window sill segments for hightened segments	[Optional]											
Clamping beam segments with 2 mm or 3 mm radius	[Optional]											
3 High clamping beam segments, 140 mm	[Optional]											
High clamping beam segments, 160 mm	[Optional]											
High clamping beam segments, 180 mm	[Optional]											
9 Rolling device (wheels)	[Optional]											

■ = standard ■ = optional

TECHNICAL DATA

PERFORMANCE, DIMENSIONS AND WEIGHT.

TBS



Model	100	125
Working length	mm 1,000	1,250
Bending capacity		
Steel 400 N/mm ²	mm 0.63	0.63
Aluminum 250 N/mm ²	mm 1.00	1.00
Stainless steel 600 N/mm ²	mm 0.50	0.50
Copper 300 N/mm ²	mm 0.80	0.80
Zinc 150 N/mm ²	mm 1.00	1.00
Overall dimensions		
Length	mm 1,235	1,369
Depth with X-shaped support stand	mm 698	698
Total height with X-shaped support stand	mm 1,133	1,156
Weight		
TBS machine without X-shaped support stand	kg 84	114
TBS X-shaped support stand	kg 17	17
Partition of segments		
Per 1 corner left + right	mm 100	100
Per 1x30/40/60/70mm	mm 2x50	1x50
Lower and bending beam segments	mm 5x100	8x100
Clamping beam segments	mm 40	40
Clamping beam opening height	mm 45	45

Page 7



UK



Model	100	125
Working length	mm 1,000	1,250
Bending capacity		
Steel 400 N/mm ²	mm 1.50	1.25
Aluminum 250 N/mm ²	mm 2.25	2.00
Stainless steel 600 N/mm ²	mm 1.00	0.80
Copper 300 N/mm ²	mm 2.00	1.50
Zinc 150 N/mm ²	mm 2.00	2.00
Overall dimensions		
Length	mm 1,480	1,730
Depth	mm 740	740
Total height	mm 1,180	1,180
Weight	kg 260	290
Partition of segments		
Per 1 corner left + right	mm 100	100
Per 1x30/40/60/70 mm	mm 6x100	8x100
Lower and bending beam segments	mm 60	60
Clamping beam segments	mm 100	100
Clamping beam opening height	mm 96	96

Page 8



UKV



Model	100	125	150	200
Working length	mm 1,000	1,250	1,500	2,000
Bending capacity				
Steel 400 N/mm ²	mm 2.00	1.75	1.50	1.00
Aluminum 250 N/mm ²	mm 3.00	2.50	2.25	1.50
Stainless steel 600 N/mm ²	mm 1.25	1.00	1.00	0.70
Copper 300 N/mm ²	mm 2.50	2.25	2.00	1.00
Zinc 150 N/mm ²	mm 2.50	2.50	2.50	2.00
Overall dimensions				
Length	mm 1,600	1,790	2,010	2,600
Depth (only for machine)	mm 800	800	800	800
Total height	mm 1,200	1,200	1,200	1,200
Weight	kg 400	450	562	625
Partition of segments				
Per 1 corner left + right	mm 100	100	100	100
Per 1x30/40/60/70 mm	mm 6x100	8x100	11x100	16x100
Lower and bending beam segments	mm 60	60	60	60
Clamping beam segments	mm 100	100	100	100
Clamping beam opening height	mm 96	96	96	96

Page 9



UKF



Model	100	125	150	200
Working length	mm 1,000	1,250	1,500	2,000
Bending capacity				
Steel 400 N/mm ²	mm 1.50	1.50	1.50	1.00
Aluminum 250 N/mm ²	mm 2.25	2.25	2.25	1.50
Stainless steel 600 N/mm ²	mm 1.00	1.00	1.00	0.70
Copper 300 N/mm ²	mm 2.00	2.00	2.00	1.00
Zinc 150 N/mm ²	mm 2.25	2.25	2.25	2.00
Overall dimensions				
Length	mm 1,340	1,697	1,840	2,340
Depth (only for machine)	mm 740	740	740	740
Total height	mm 1,485	1,485	1,485	1,485
Weight	kg 530	560	683	845
Partition of segments				
Per 1 corner left + right	mm 100	100	100	100
Per 1x30/40/60/70 mm	mm 6x100	8x100	11x100	16x100
Lower and bending beam segments	mm 120	120	120	120
Clamping beam segments	mm 160	160	160	160
Clamping beam opening height	mm 96	96	96	96

Page 10



SB



Model	50
Working length	mm 2x550
Bending capacity	
Steel 400 N/mm ²	mm 1.00
Aluminum 250 N/mm ²	mm 1.50
Stainless steel 600 N/mm ²	mm 0.60
Copper 300 N/mm ²	mm 1.25
Zinc 150 N/mm ²	mm 1.50
Overall dimensions	
Length	mm 1,410
Depth	mm 1,005
Total height	mm 1,600
Weight	kg 265
Partition of segments	
Per 1 corner left + right	mm 100
Per 1x30/40/50/60/70/100 mm	
Clamping beam opening height	mm 86



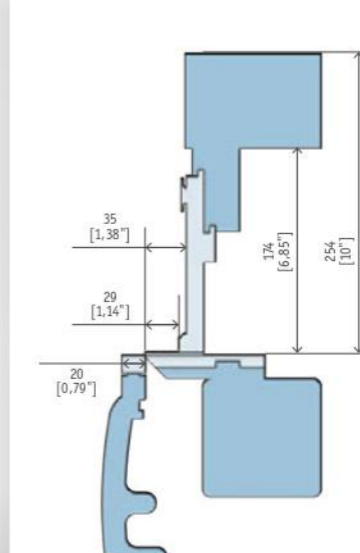
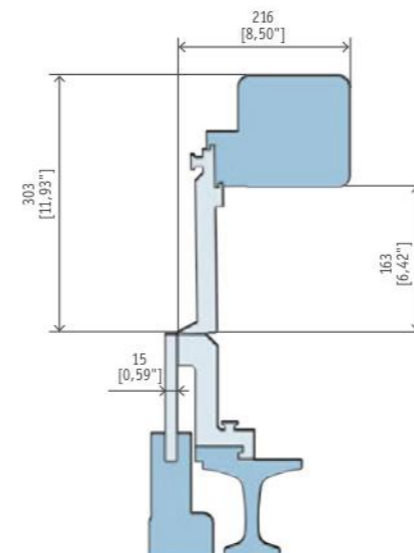
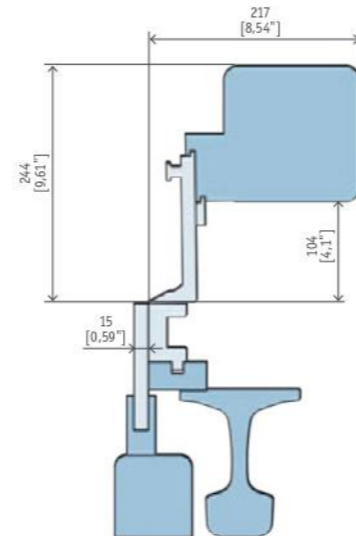
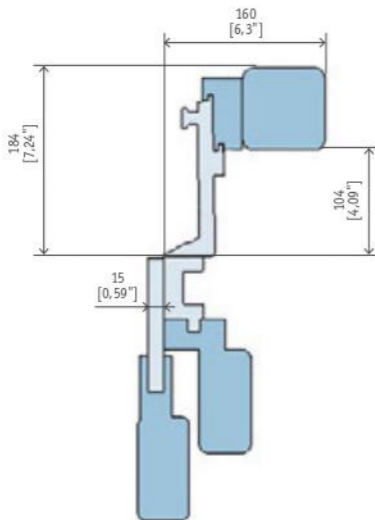
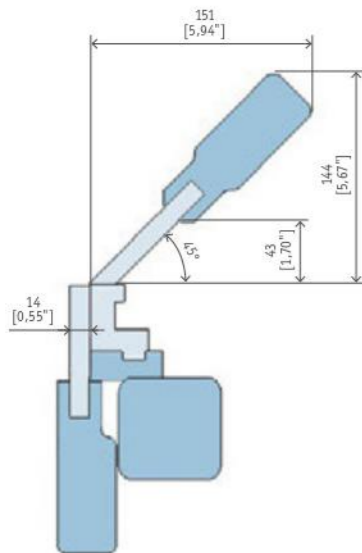









Page 11



LINE-UP OF MACHINES

MACHINES FOR THE ENTIRE
RANGE OF TOP-QUALITY METALWORKING
AS OF 01/2022

MANUAL BENDING MACHINES

 <p>TBX</p> <ul style="list-style-type: none"> Single-user lightweight for the job site Max. portability, solid, ready to use in 2 min Unique X stand, foldable, on wheels 	 <p>LBT</p> <ul style="list-style-type: none"> Construction convenience: bending, cutting, beading Portable, wheel locks, smooth-running Versatile options for clamping beam rail 	 <p>LBX</p> <ul style="list-style-type: none"> Compact and powerful on-site bending Pretensioning for material type and thickness Optimal bending result across the working width 	 <p>TBS</p> <ul style="list-style-type: none"> Smart segment-bending at the job site Tool-free adjustment, many fold shapes Unique X stand, light, max. portability
 <p>UK</p> <ul style="list-style-type: none"> Smart segment-bending, proven 10,000 times Combine elements without tools Foot pedal, frees up hands for positioning 	 <p>UKV</p> <ul style="list-style-type: none"> Segment-bending even more powerful/versatile Fast and tool-free segment adjustment Hands stay free for precision positioning 	 <p>UKF</p> <ul style="list-style-type: none"> Segment bending of large special forms Extra high standards for use – XXL freedom Maximum flexibility, highest comfort 	 <p>KS</p> <ul style="list-style-type: none"> Incredibly versatile, fast, cost-effective Easy and convenient for creative profiles World's best-selling swivel bending machine
 <p>KSV</p> <ul style="list-style-type: none"> Award-winning, cost-effective, versatile Handles many materials and thicknesses Produces remarkable profiles 	 <p>HBM</p> <ul style="list-style-type: none"> Special profiles only possible here Precise positioning of workpieces Simple lowering of bending beam 	 <p>HA</p> <ul style="list-style-type: none"> Sturdy package for single-user operation Specially designed for thick sheets Ideal configuration for recurring bends 	 <p>SB50</p> <ul style="list-style-type: none"> For the production of roof and facade shingles Only one work step for two 180° edges Time saving of approx. 70 %

MOTORIZED BENDING MACHINES

 <p>MBM ECT</p> <ul style="list-style-type: none"> Smart move to motor and monitor system Precision reproduction of complex profiles Single-user operation, sturdy, time-efficient 	 <p>MAX</p> <ul style="list-style-type: none"> Motorized model with best custom versatility Sturdy construction, high bending capacity The classic for 90% of all bending jobs 	 <p>MAX-F</p> <ul style="list-style-type: none"> Maximum bending free space 14 mm free space behind the pivot point More space for profile geometries 	 <p>MAB</p> <ul style="list-style-type: none"> More power than MAX, better performance Powerful machine for roofs and exteriors Sturdy construction, minimal maintenance
 <p>MAZ CNC</p> <ul style="list-style-type: none"> Best in series production and light metal Speed king: outstanding productivity Shortest setup times, rapid bending sequences 	 <p>MAE CNC</p> <ul style="list-style-type: none"> Economical in the industrial trade Most adaptable changeover system / 1-click Minimal setup times, versatile, compact 	 <p>MAF CNC</p> <ul style="list-style-type: none"> Maximum bending free space – without special tools 14 mm free space behind the pivot point Low risk of collision on the bending beam 	

MANUAL SHEARS



HT

- Resiliently sturdy: lasts for generations
- Single-user operation, economical precision
- Space-saving, maintenance-free, lots of accessories

MOTORIZED SHEARS

 <p>SMT</p> <ul style="list-style-type: none"> Smallest 3-meter motorized squaring shear For thin sheets to strong materials Saves energy, space and time 	 <p>MSB</p> <ul style="list-style-type: none"> Small size of SMT with much more power Even more performance in single-user operation The powerful and cost-effective choice 	 <p>MSC</p> <ul style="list-style-type: none"> The pro for thin sheets and exterior work Two motors, equal power distribution High efficiency, min. energy consumption
---	---	--

SHEARS FOR CUT-TO-LENGTH LINE SYSTEMS



MT

- Integrated automatic shearing system
- For continuous operation in the production process
- Individually adaptable, minimal maintenance



ST

- Shearing system with best configurability
- Integration into serial production equipment
- For many other materials besides sheet metals

MODULAR COIL-HANDLING



MCH

- Metal sheets are always available
- Modular design
- Customizable

PROFILING MACHINES



SZP

- Extra-long and very solid in ventilation work
- Straight-line profiling without distortion
- High operating cycle speed



stamac
ENGINEERING CONSULTANT

WJS
 ANTEEN
 3D USED
 SERVICE
 PROJECT CONSULTING
 ON ENGINEERING
 SCHLEBACH CLADDING MACHINERY SAFETY G.A.D.E. COLLINES, BSE
 WINING, NEW AND USED MACHINERY SCH CHTL, GUILLOTINES, PROJECT MAN
 AGING, PANEL
 INTENANCE, SPECIAL BUILT
 CY-LASER
 CY-LASER VARIOBEND
 G.A.D.E. COLLINES, BREAKDOWN, PRESSBRACKES, CY-LASER OPERATOR TRAINING, NEW AND USED MACHINERY
 GUILLOTINES, PROJECT CONSULTING, OHS, WJS, RI BOTS, LASERS, SLITTING CUT TO LENGTH LINES, SP
 G.A.D.E. ELECTRICAL MAINTENANCE OPERATOR TRAINING, NEW AND USED MACHINERY, SCHECHT, E
 KIT PUMP SERVICE, PAN-RAP
 CLADDING MACHINERY, WJS, PRESSBRACKES, RI
 WJS SAFETY, OHS CONSULTING, G.A.D.E. F
 TUBE BENDING, VARIOBEND
 SCH CHTL ELECTRIC
 PAN-RAP
 CY-LASER

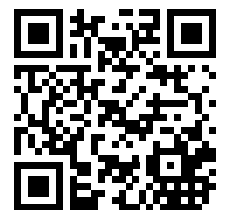

STAMAC ENGINEERING PTY LTD

59 Naxos Way, Keysborough, Victoria 3173

Phone / Fax: +613 9769 3988

Mobile: +61451 665 316

Email: peter@stamac.com.au

Web: www.stamac.com.au